

### Features

- Bask® heated surface creates spa-like relaxation with soothing warmth on your back, shoulders, and neck.
- Three heat settings allow you to customize the surface temperature.
- Single-speed whirlpool offers performance and value with 8 fully adjustable jets.
- Hydromassage flow and direction can be controlled at each jet.
- Comfort Depth® design offers a convenient 19" step-over height while retaining the same depth as a standard 21" bath.
- Generous length provides a spacious bathing area.
- Integral lumbar support and armrests offer extra comfort while bathing.
- Slotted overflow allows for deep soaking.
- Integral apron.
- Integral flange helps prevent water from seeping behind wall and simplifies alcove installation.
- Textured bottom surface.
- Coordinates with other products in the Archer collection.

### Material

- Acrylic.

### Hydrotherapy

- Whirlpool.

### Installation

- Left drain.
- Alcove.

### Required Products/Accessories

K-7271 Brass Slotted Overflow Bath Drain

or

K-7272 PVC Slotted Overflow Bath Drain

### Recommended Products/Accessories

K-9529 Removable Bath Seat

K-24916 Wireless Music Kit

K-23726 Drain treatment

K-23732 Tub & shower cleaner



ADA

### Codes/Standards

ASME A112.19.7/CSA B45.10

CSA B45.5/IAPMO Z124

ASTM E162

ASTM E662

UL 1795

ADA







ICC/ANSI A117.1

**KOHLER® Plastic Baths and  
Receptors Lifetime Limited  
Warranty KOHLER® Hydrotherapy  
Components Five-Year Limited  
Warranty**

See website for detailed warranty information.

### Available Colors/Finishes

*Color tiles intended for reference only.*

Color	Code	Description
	0	White
	96	Biscuit
	NY	Dune
	95	Ice™ Grey
	58	Thunder™ Grey
	7	Black Black™

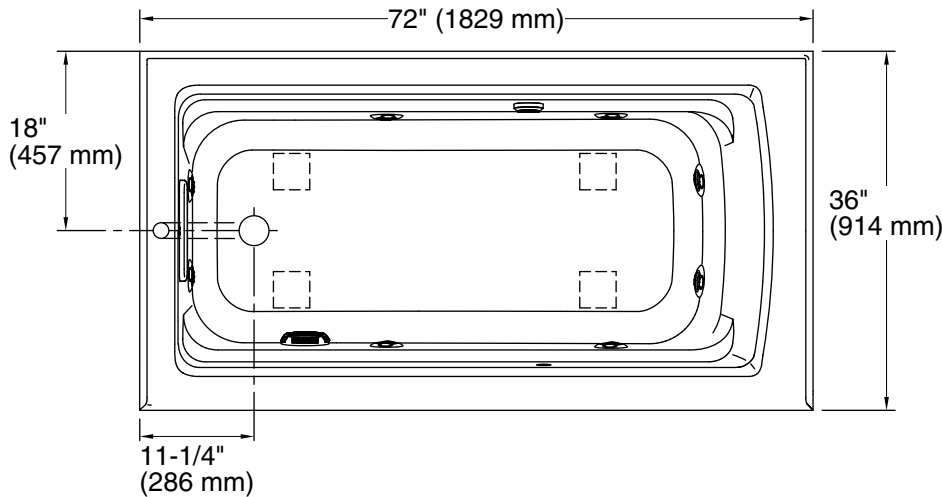

No change in measurements if connected with drain illustrated. (K-7272)

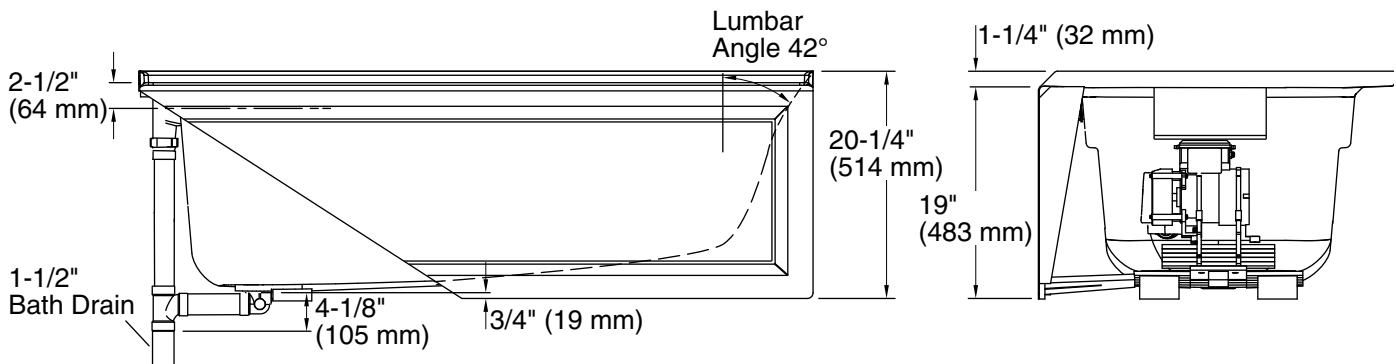
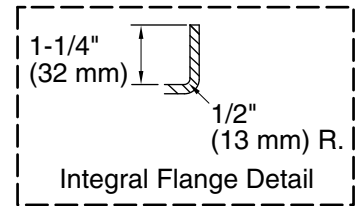

### Required Electrical Service

One dedicated circuit required, protected with Class A Ground-Fault Circuit-Interrupter (GFCI). Outside North America, this device may be known as a Residual Current Device (RCD).

Pump, Heated      120 V, 15 A, 60 Hz  
Surface:

### Technical Information

All product dimensions are nominal.

Installation:      Three-wall alcove  
Drain location:    Left  
Basin area, bottom: 51-3/8" x 21" (1305 mm x 533 mm)  
Basin area, top:    64-1/2" x 30-1/2" (1638 mm x 775 mm)  
Weight:            141 lbs (64 kg)  
Minimum floor load: 43 lbs/ft<sup>2</sup> (209.9 kg/m<sup>2</sup>)  
Water depth:      15" (381 mm)  
Water capacity:    72 gal (272.5 L)  
Electrical component rating: Pump: 120 V, 7 A, 60 Hz  
Heated Surface: 120 V, 0.5 A, 60 Hz  
Pump speed:      Single

### Notes

Measure your actual product for rough-in details.

Install this product according to the installation instructions.

The hot water supply should be 70% of the capacity of the bath or greater. Installations will vary.

ADA compliant when installed to the specific requirements of these regulations.